

EnduroLite

Your reliable partner for domestic and industrial drainage, sewage tank, and wastewater applications.



EnduroLite

Your reliable partner for domestic and industrial drainage, sewage tank, and wastewater applications.

EnduroLite is a specially developed single-phase submersible pump series designed for domestic and light industrial applications. It offers user-friendly solutions with a 10-meter cable, float switch, and panel options in some models. Its compact design, reliable performance, and competitive prices provide fast solutions.



Areas of Use

- Drainage and rain water drainage
- Basement and elevator pit drainage
- Sewage tank and grey water discharge
- Ornamental pool, waterfall, backwater transfer
- Light industrial wastewater applications

Technical Specifications

Motor Electrical Connection	1~230 V, 50 Hz
Fluid Temperature	0 – 30 °C
Motor Protection and Insulation Class	IP 68 / F
Insulation Class	C,IF

Advantages and Benefits

EnduroLite single-phase submersible pumps reduce electricity consumption thanks to their energy-efficient motors operating at high efficiency, thus offering both an environmentally friendly use and significantly reducing your operating costs.

Manufactured with durable materials and superior craftsmanship, EnduroLite delivers reliable, uninterrupted performance for years, even in harsh operating conditions. It is resistant to corrosion thanks to its stainless steel and high-quality plastic material options.

Its compact and lightweight design facilitates installation and transportation, allowing it to be used comfortably even in confined spaces. This saves time and labor.

Its silent operation ensures that the pump performs without causing disturbance in the environment where it is used; it is particularly preferred for residential and garden applications.

Maintenance and repair processes are carried out quickly and practically thanks to their easy-to-access design. This extends the pump's service life and minimizes downtime.

With a wide service network and spare parts supply, users can always access fast and reliable technical support. This allows EnduroLite users to continue using their products with confidence in the long term.

Furthermore, thanks to EnduroLite's high performance, water lifting capacity is optimized, providing effective solutions for various applications such as irrigation, drainage, and water supply.

Standard Material Feature

Model	Impeller Type			Materials				Free Passage
	Open	Closed	Grinder	Casing Material	Impeller Material	Shaft Material	Mechanical Seal	Max. Particle (mm)
EnduroLite 50	✓			Technopolymer	Noryl	AISI 304	Silicon/Silicon	3
EnduroLite 100	✓			Technopolymer	Noryl	AISI 304	Silicon/Silicon	3
EnduroLite 150	✓			Technopolymer	Noryl	AISI 304	Silicon/Silicon	3
EnduroLite 150F	✓			Technopolymer	AISI 304	AISI 304	Silicon/Silicon	20
EnduroLite 150S		✓		AISI 304	AISI 304	AISI 304	Silicon/Silicon	6
EnduroLite 200S	✓			AISI 304	AISI 304	AISI 304	Silicon/Silicon	6
EnduroLite 150PB			✓	AISI 304	GG 25	AISI 304	Silicon/Silicon	-
EnduroLite 180PB			✓	AISI 304	GG 25	AISI 304	Silicon/Silicon	-
EnduroLite 190PB			✓	AISI 304	GG 25	AISI 304	Silicon/Silicon	-

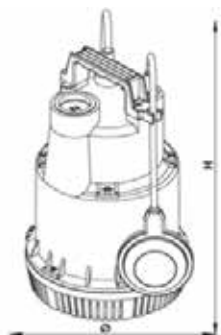

Model	Features			Dimensions	
	Power (kW)	Discharge Diameter	Weight (kg)	Q (mm)	H (mm)
EnduroLite 50	0.33	1"	5,2	147	248
EnduroLite 100	0,65	1 ¹ / ₄ "	12	180	326
EnduroLite 150	1	1 ¹ / ₄ "	13	180	326

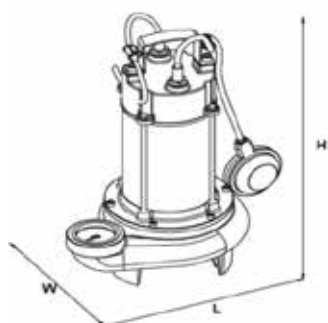

Model	Features			Dimensions		
	Power (kW)	Discharge Diameter	Weight (kg)	W (mm)	L (mm)	H (mm)
EnduroLite 150F	1,1	2"	14	185	195	400
EnduroLite 150S	1,1	1 ¹ / ₂ "	17	185	260	350
EnduroLite 200S	1,35	2"	23	200	280	430
EnduroLite 150PB	1,1	2"	23,5	200	280	430
EnduroLite 180PB	1,35	2"	23,5	200	280	430
EnduroLite 190PB	1,35	2"	25	200	280	430

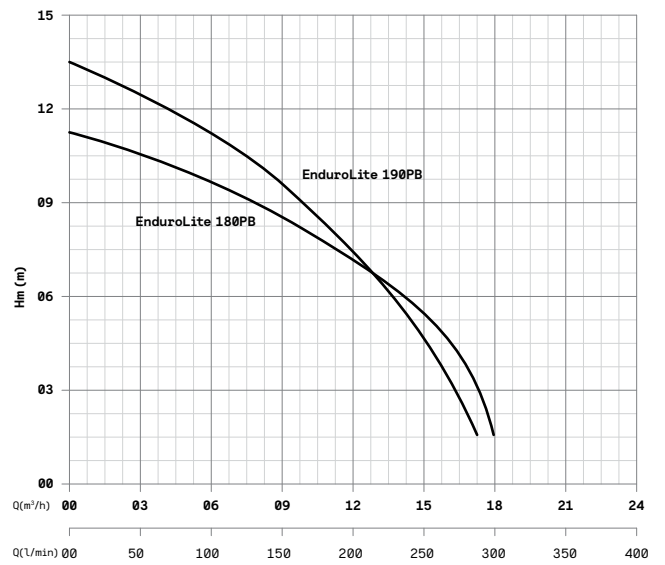
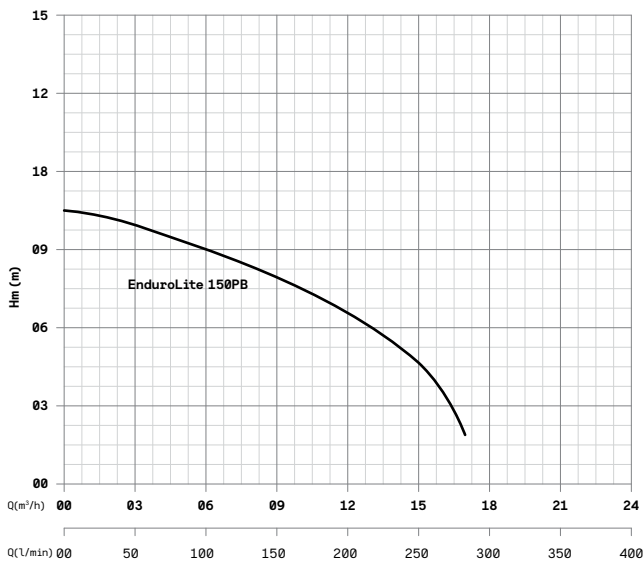
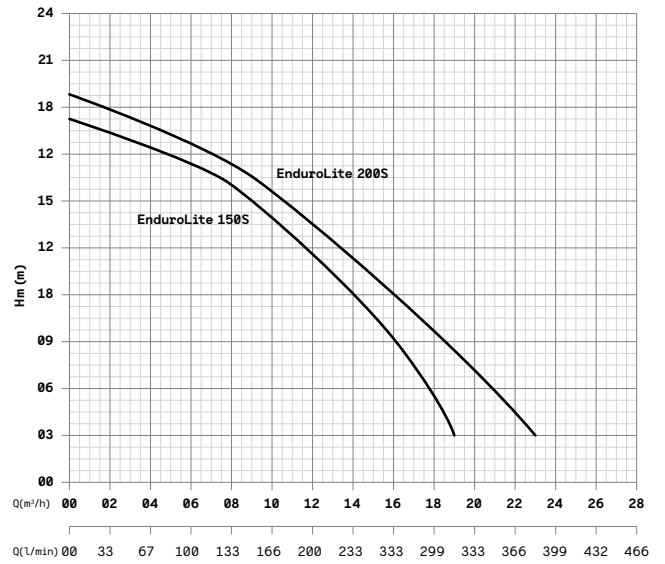
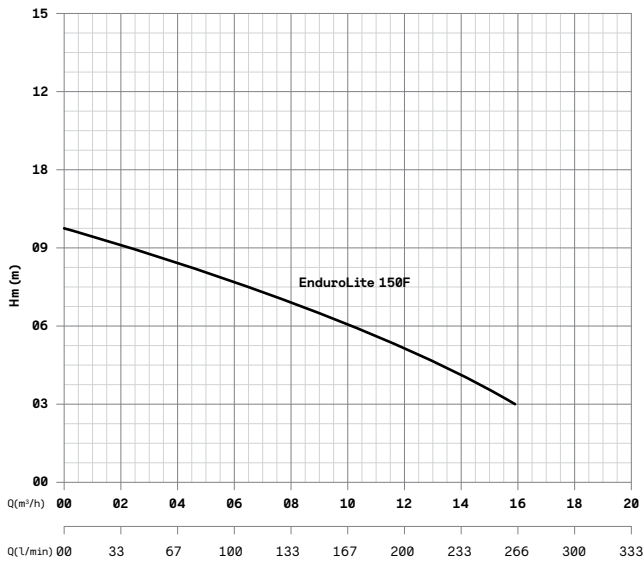
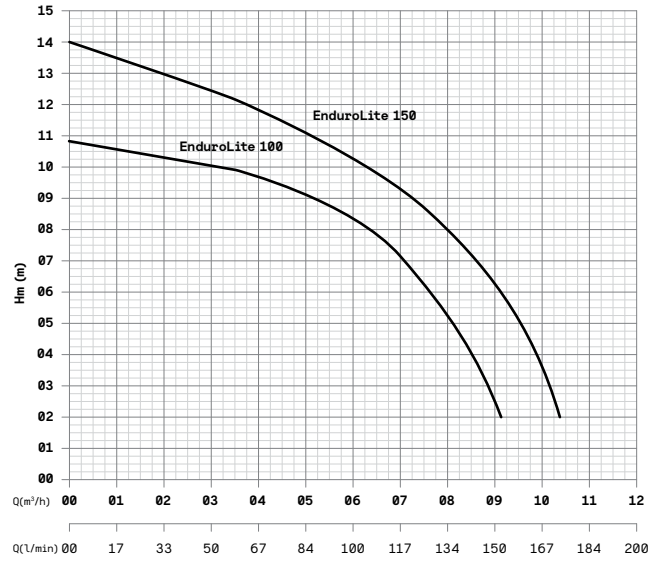
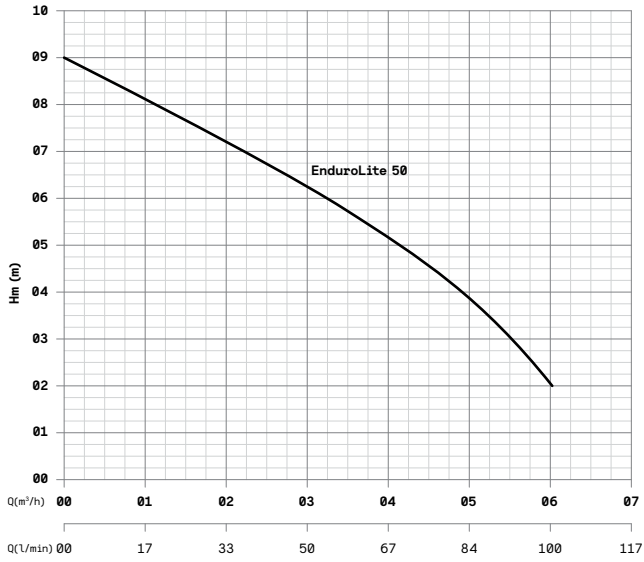

*Making
The World
Better!*



Customer Service
+90 850 888 8 627

Orta Mahallesi Atayolu Caddesi
No:16 Tuzla - İstanbul / Türkiye

 [masdaf.com](https://www.masdaf.com)